

1. CARACTERÍSTICAS TÉCNICAS

Serie LP-50

Sistema de carpintería coplanar para la fabricación de puertas de tránsito intenso de gran versatilidad, resistencia y fácil construcción.

Ensamblaje de perfiles con escuadras de bloqueo mecanizadas.

Marco y hojas de 45mm con espesor general de 1,8 mm.

Conjunto de herrajes específicos con alojamiento de cámara central.

Diversos perfiles para la fabricación de puertas de 1 o 2 hojas de apertura interior o exterior con o sin cierre inferior, fijos laterales y superiores, además de solución para puerta vaivén de 1 o 2 hojas.

Sistema de estanqueidad por doble junta de EPDM de altas prestaciones.

Gama de acristalamiento hasta 32 mm.



2. PRESTACIONES

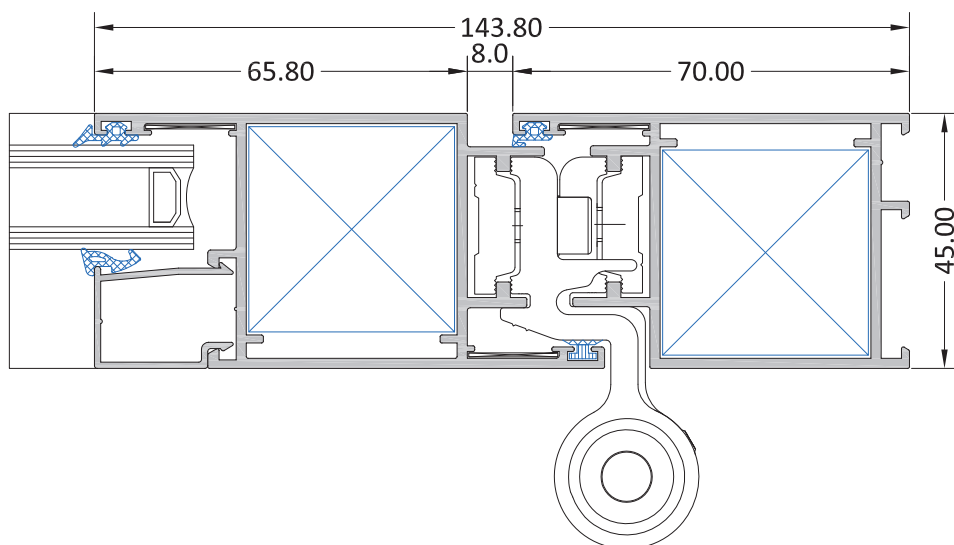



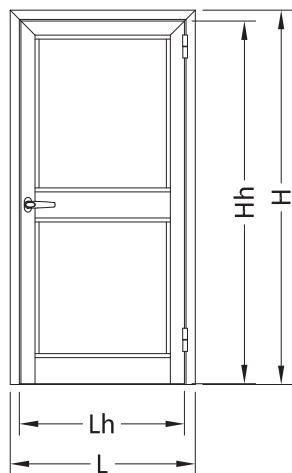









DIMENSIONES MÁXIMAS DE HOJA

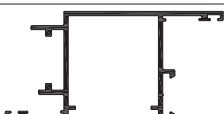
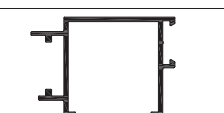

PUERTAS USO RESIDENCIAL	120 kg
PUERTAS USO PÚBLICO	110 kg
PUERTAS USO PÚBLICO CON CIERRAPUERTAS SIN FRENO DE APERTURA	100 kg
PUERTAS USO PÚBLICO CON CIERRAPUERTAS CON FRENO DE APERTURA	90 kg

1. El montaje de las bisagras debe efectuarse en los extremos superior e inferior de la puerta.
2. La relación altura/anchura de la puerta debe ser igual o superior a 2. Para relaciones altura/anchura menores, la capacidad se reduce en la medida de un 10% por cada 0,1 mm de reducción de la relación.
3. Aumento de capacidad debido a tercera bisagra montada arriba, en proximidad a bisagra superior: + 15 %
No se obtiene ningún aumento de capacidad montando una tercera bisagra en el centro de la puerta.

3. RELACION DE PERFILES

Sección	Referencia	Denominación	Peso (kg)	Perímetro (m)	Inercia (cm ⁴) $\begin{matrix} y \\ \\ x \end{matrix}$
	5920	Junquillo recto 4 mm.	0,170	0,103	$\begin{matrix} I_x = 0.36 \\ I_y = 0.21 \end{matrix}$
	5921	Junquillo recto clipado 10.5 mm	0,215	0,142	$\begin{matrix} I_x = 0.49 \\ I_y = 0.23 \end{matrix}$
	6019	Junquillo recto clipado 22.4 mm	0,232	0,157	$\begin{matrix} I_x = 0.54 \\ I_y = 0.55 \end{matrix}$
	6020	Junquillo recto clipado 26.5 mm	0,273	0,182	$\begin{matrix} I_x = 0.66 \\ I_y = 0.75 \end{matrix}$
	6021	Junquillo recto clipado 18 mm	0,203	0,138	$\begin{matrix} I_x = 0.49 \\ I_y = 0.39 \end{matrix}$
	5050	Marco	1,193	0,502	$\begin{matrix} I_x = 13.18 \\ I_y = 18.14 \end{matrix}$
	5051	Hoja apertura interior	1,308	0,556	$\begin{matrix} I_x = 15.39 \\ I_y = 25.01 \end{matrix}$
	5052	Hoja apertura exterior	1,308	0,556	$\begin{matrix} I_x = 14.63 \\ I_y = 25.01 \end{matrix}$
	5053	Inversor	0,803	0,342	$\begin{matrix} I_x = 4.55 \\ I_y = 3.38 \end{matrix}$
	5054	Travesaño 50	1,187	0,460	$\begin{matrix} I_x = 11.57 \\ I_y = 13.27 \end{matrix}$
	5055	Travesaño 130	2,051	0,780	$\begin{matrix} I_x = 26.24 \\ I_y = 157.82 \end{matrix}$
	5056	Hoja vaivén	1,077	0,463	$\begin{matrix} I_x = 12.55 \\ I_y = 15.52 \end{matrix}$
	5057	Suplemento marco	0,557	0,233	$\begin{matrix} I_x = 1.02 \\ I_y = 4.57 \end{matrix}$
	5058	Cierre inferior	0,481	0,228	$\begin{matrix} I_x = 0.82 \\ I_y = 4.56 \end{matrix}$

4. PERFILES

5050 - Marco

Peso (Kg/m)	1.193				
Perímetro (m)	Ext.	0.334	Inercia (cm ⁴)	Ix	18.14
	Total	0.502		Iy	13.18

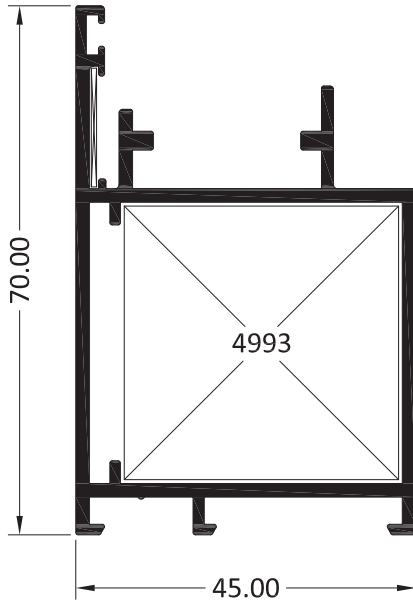

5056 - Hoja vaivén

Peso (Kg/m)	1.077				
Perímetro (m)	Ext.	0.295	Inercia (cm ⁴)	Ix	15.52
	Total	0.463		Iy	12.55

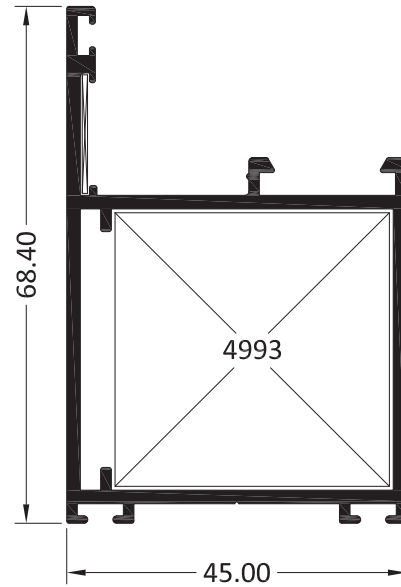

5051 - Hoja apertura interior

Peso (Kg/m)	1.308				
Perímetro (m)	Ext.	0.388	Inercia (cm ⁴)	Ix	25.01
	Total	0.556		Iy	15.39

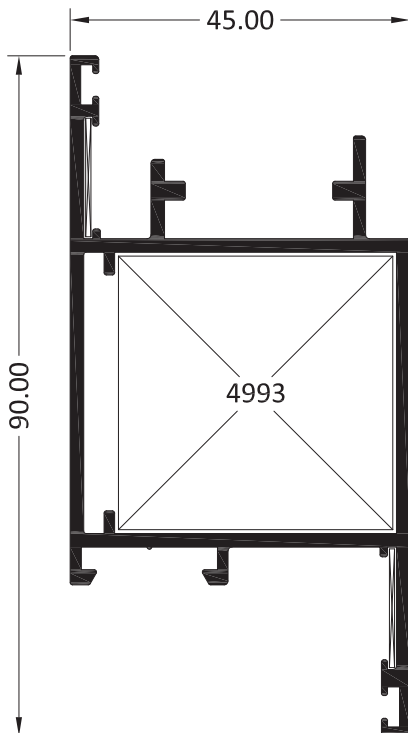

5052 - Hoja apertura exterior

Peso (Kg/m)	1.308				
Perímetro (m)	Ext.	0.387	Inercia (cm ⁴)	Ix	25.01
	Total	0.556		Iy	14.63

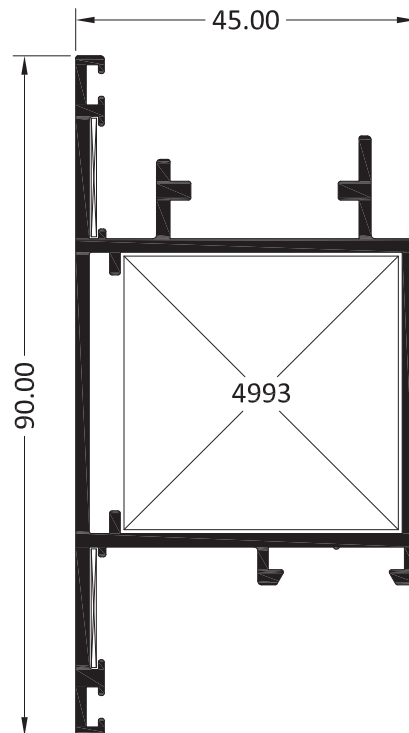

4. PERFILES

5053 - Inversor

Peso (Kg/m) 0.803

Perímetro (m)	Ext.	0.246	Inercia (cm ⁴)	Ix	3.38
	Total	0.342		Iy	4.55

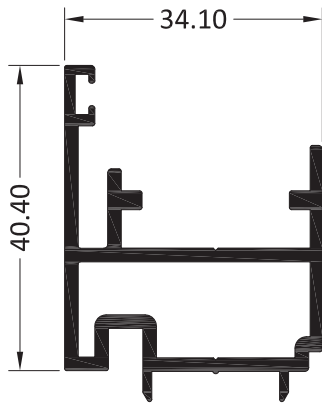

5055 - Travesaño 130

Peso (Kg/m) 2.051

Perímetro (m)	Ext.	0.433	Inercia (cm ⁴)	Ix	157.82
	Total	0.780		Iy	26.24

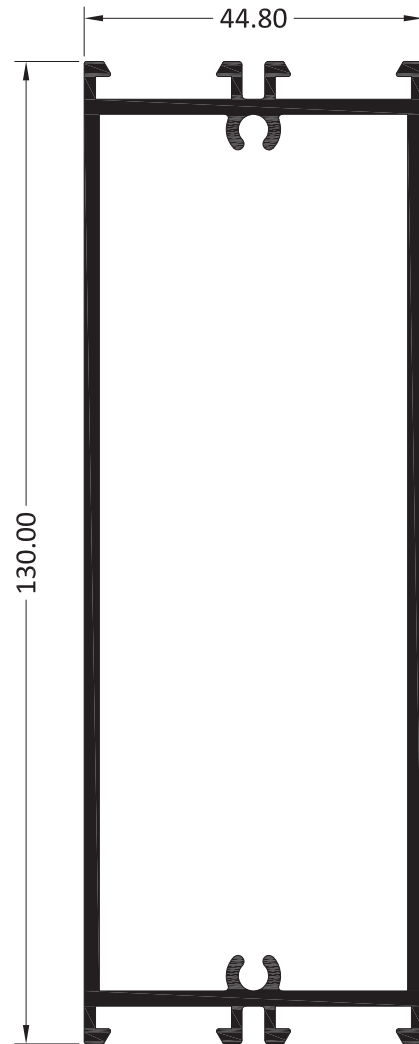

5054 - Travesaño 50

Peso (Kg/m) 1.187

Perímetro (m)	Ext.	0.273	Inercia (cm ⁴)	Ix	13.27
	Total	0.460		Iy	11.57

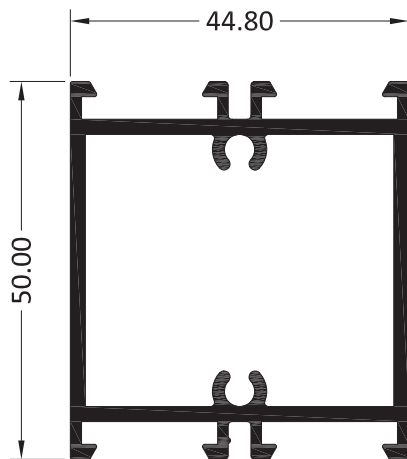

4. PERFILES

5057 - Suplemento marco

Peso (Kg/m)		0.557			
Perímetro (m)	Ext.		Inercia (cm ⁴)	lx	1.02
	Total	0.233		ly	4.57

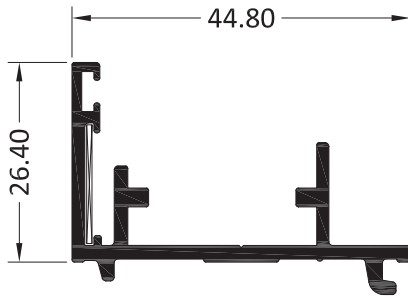

5058 - Cierre inferior

Peso (Kg/m)		0.481			
Perímetro (m)	Ext.		Inercia (cm ⁴)	lx	0.82
	Total	0.228		ly	4.56

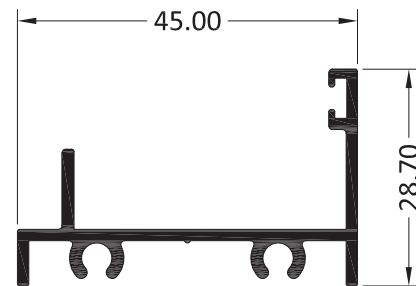

5059 - Suplemento zócalo/vaivén

Peso (Kg/m)		0.274			
Perímetro (m)	Ext.		Inercia (cm ⁴)	lx	0.02
	Total	0.139		ly	2.18

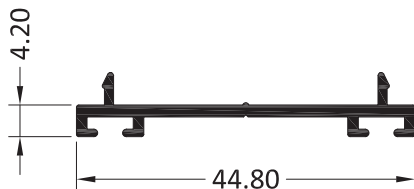

5060 - Cierre suelo enrasado

Peso (Kg/m)		0.300			
Perímetro (m)	Ext.		Inercia (cm ⁴)	lx	0.03
	Total	0.136		ly	2.00

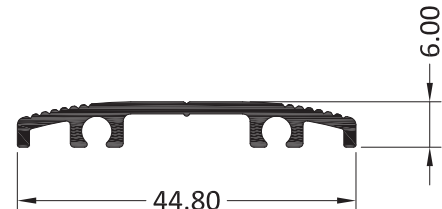

4. PERFILES

5920 - Junquillo recto 4 mm					5921 - Junquillo recto 10.5 mm					6019 - Junquillo recto 22.4 mm																
Peso (Kg/m)		0.170		Inercia(cm ⁴)			Peso (Kg/m)		0.215		Inercia(cm ⁴)			Peso (Kg/m)		0.232		Inercia(cm ⁴)								
Perímetro (m)	Ext.				Ix		0.36		Perímetro (m)	Ext.				Ix		0.49		Perímetro (m)	Ext.				Ix		0.54	
	Total		0.103		Iy		0.21			Total		0.142		Iy		0.23			Total		0.157		Iy		0.55	
6020 - Junquillo recto 26.5 mm					6021 - Junquillo recto 18 mm																					
Peso (Kg/m)		0.273		Inercia(cm ⁴)			Peso (Kg/m)		0.203		Inercia(cm ⁴)															
Perímetro (m)	Ext.				Ix		0.66		Perímetro (m)	Ext.				Ix		0.49										
	Total		0.182		Iy		0.75			Total		0.138		Iy		0.39										

5. RELACION DE ACCESORIOS

ARTÍCULO	DISEÑO	ARTÍCULO	DISEÑO
Tapón inversor LP-50 4990			
Goma marco LP-50 4991			
Goma hoja LP-50 4992			
Escuadra marco y hoja LP-50 4993			
Bisagra 120 kg. LP-50 4994			
Pasador superior LP-50 4995			
Pasador inferior LP-50 4996			
Cerradero superior LP-50 4997			
Encuentro a suelo LP-50 4998			

6. ACRISTALAMIENTO

REFERENCIA	SECCIÓN	HUECO	VIDRIO
5920		37.2	36 - 28
5921		30.7	29 - 22
6021		23.2	22 - 15
6019		18.8	17 - 10
6020		14.7	13 - 4

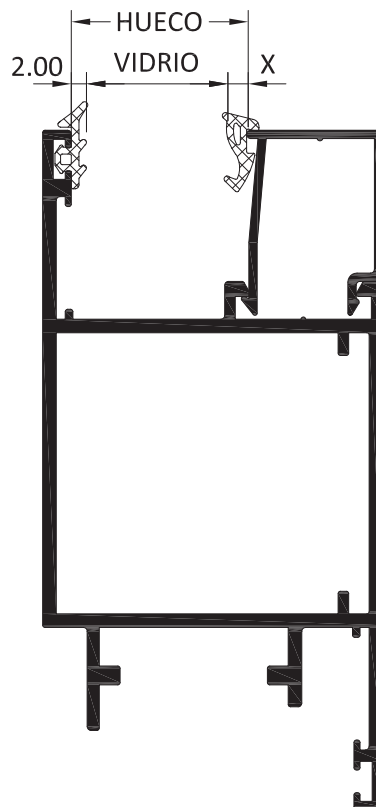

Recomendaciones de posicionamiento de los calzos según tipos de apertura

- (C1) Calzo de apoyo
- (C2) Calzo perimetral

FIJO

BATIENTE

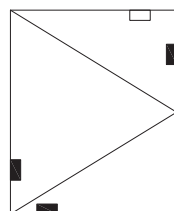
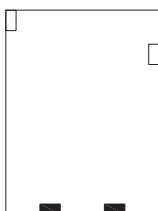

La distancia mínima entre la esquina del bastidor y el borde más cercano del calzo, tanto C1 como C2, nunca debe ser menor de 50 mm.

7. SECCIONES

POSIBILIDADES CONSTRUCTIVAS

PUERTA 1 HOJA
AP. INTERIOR

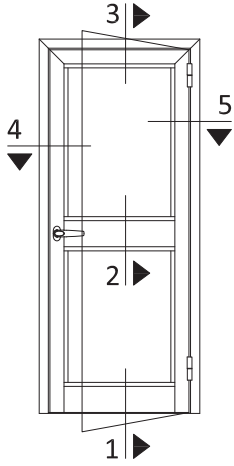

PUERTA 2 HOJAS
AP. INTERIOR

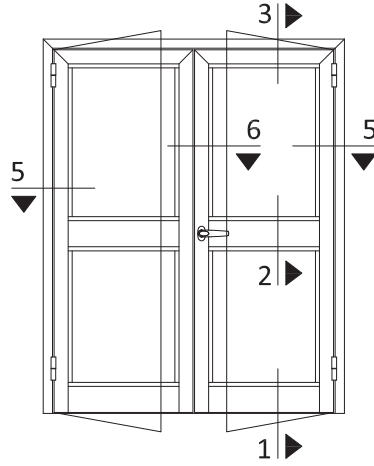

PUERTA 1 HOJA
AP. EXTERIOR

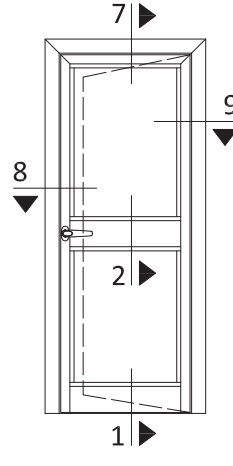

PUERTA 2 HOJAS
AP. EXTERIOR

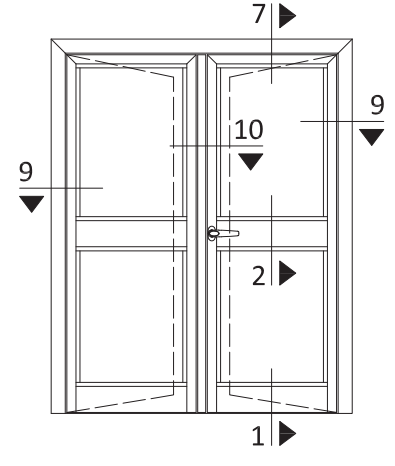

PUERTA 2 HOJAS APERTURA
INTERIOR CON FIJOS

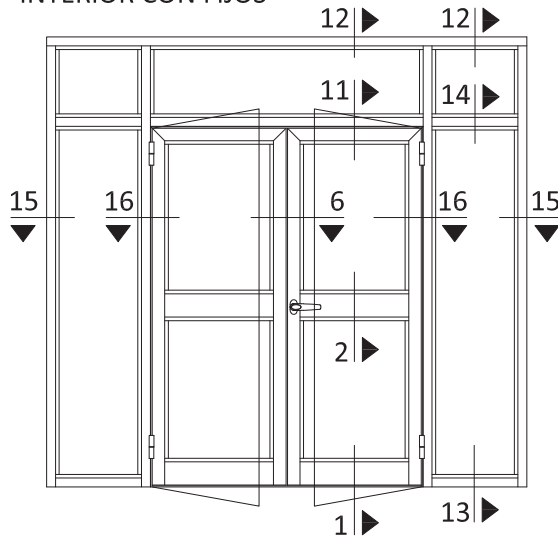

PUERTA 2 HOJAS APERTURA
EXTERIOR CON FIJOS

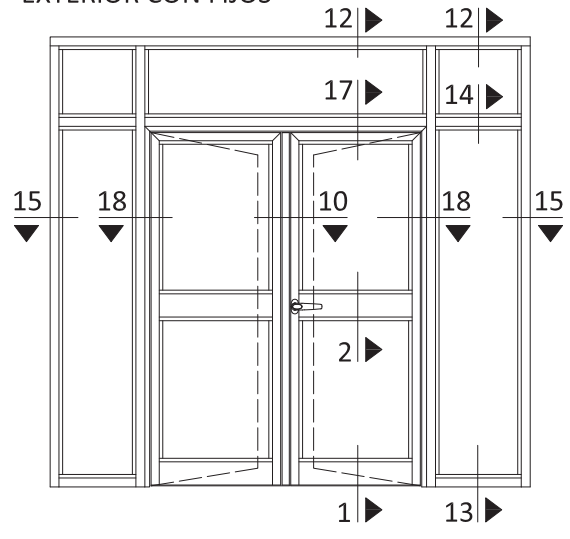

VAIVÉN 1 HOJA

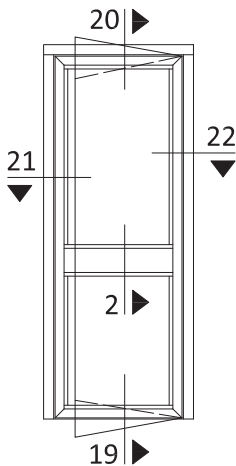

VAIVÉN 2 HOJAS

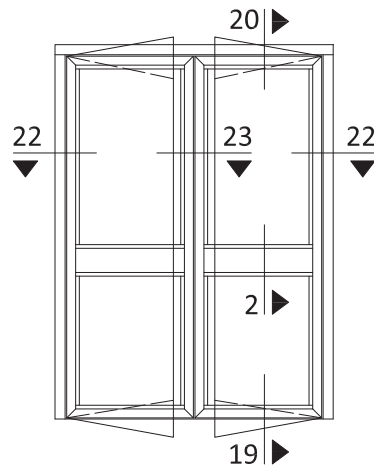

VAIVÉN 2 HOJAS CON FIJOS

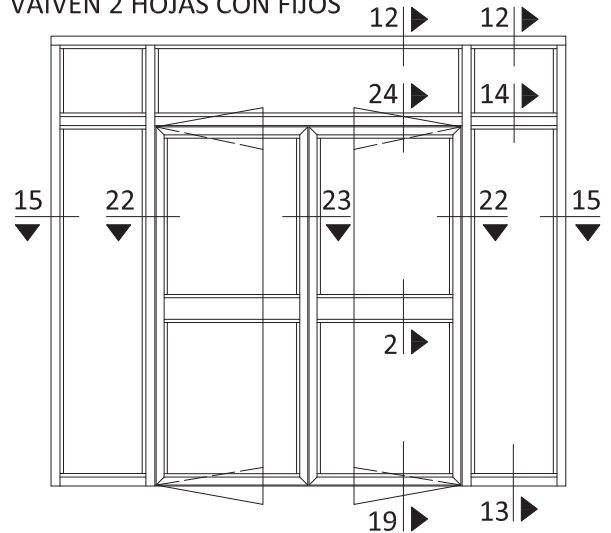

7. SECCIONES

SECCIÓN 1

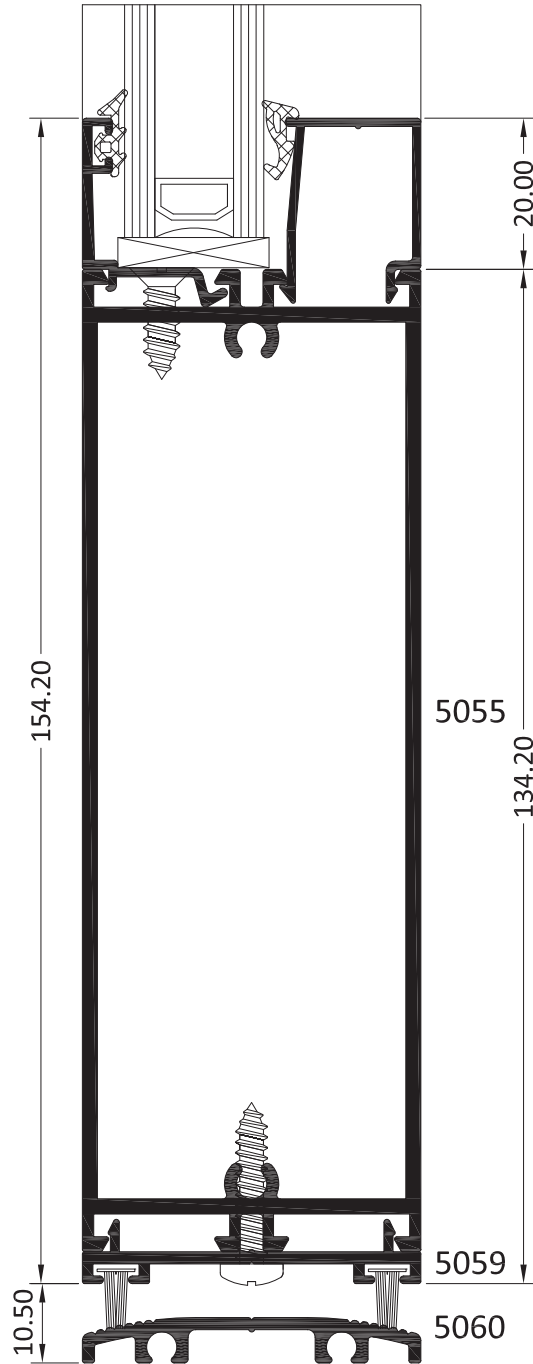

SECCIÓN 2

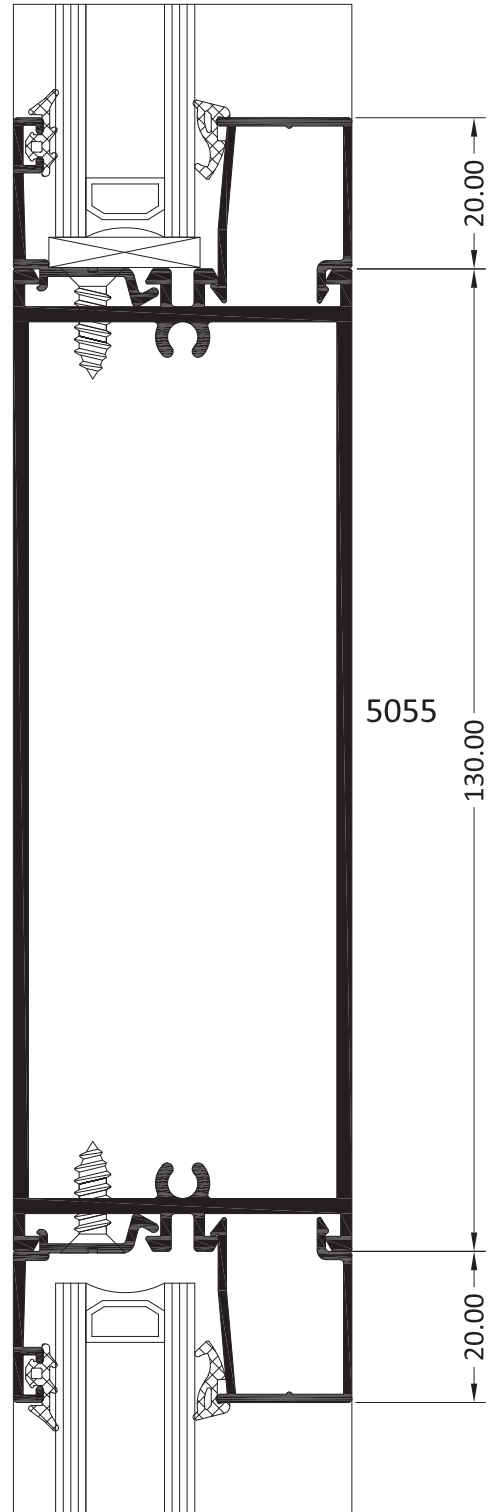

7. SECCIONES

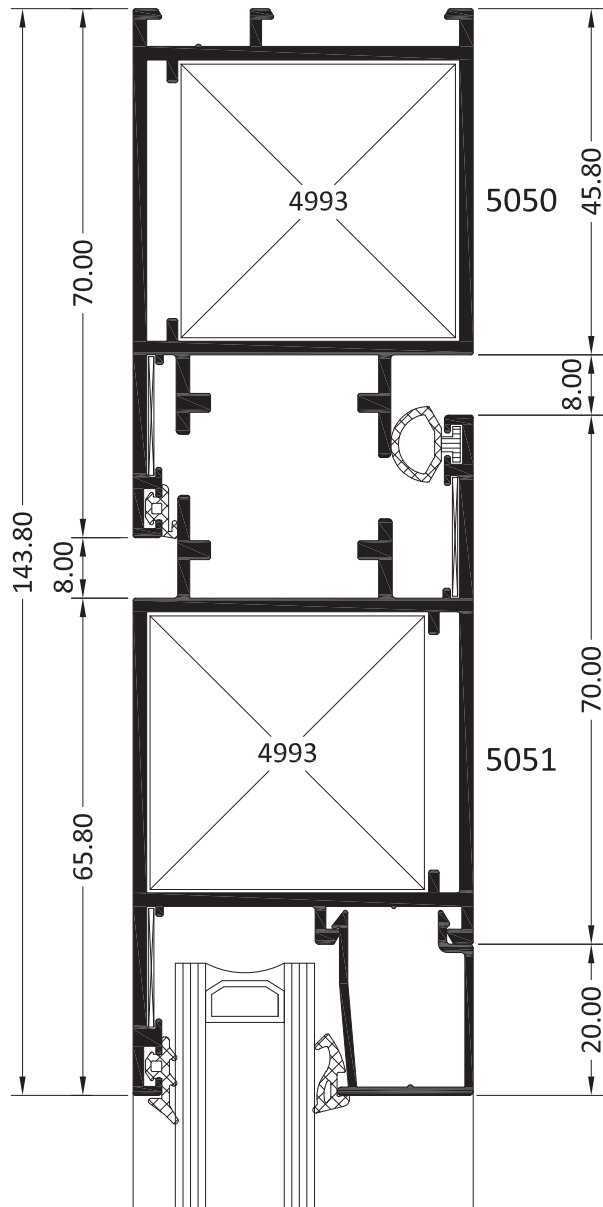

SECCIÓN 3

SECCIÓN 4

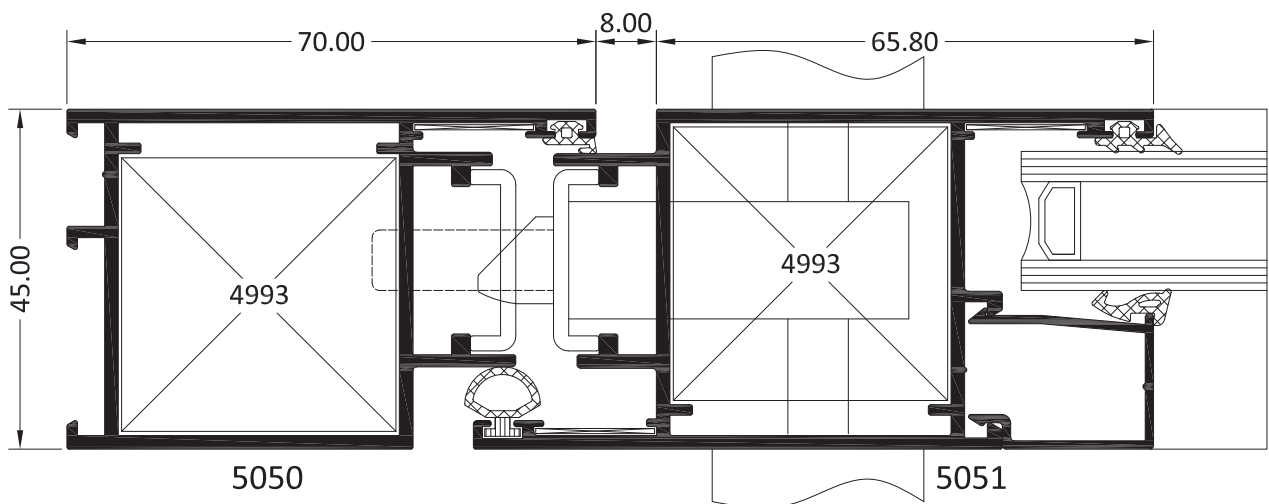

7. SECCIONES

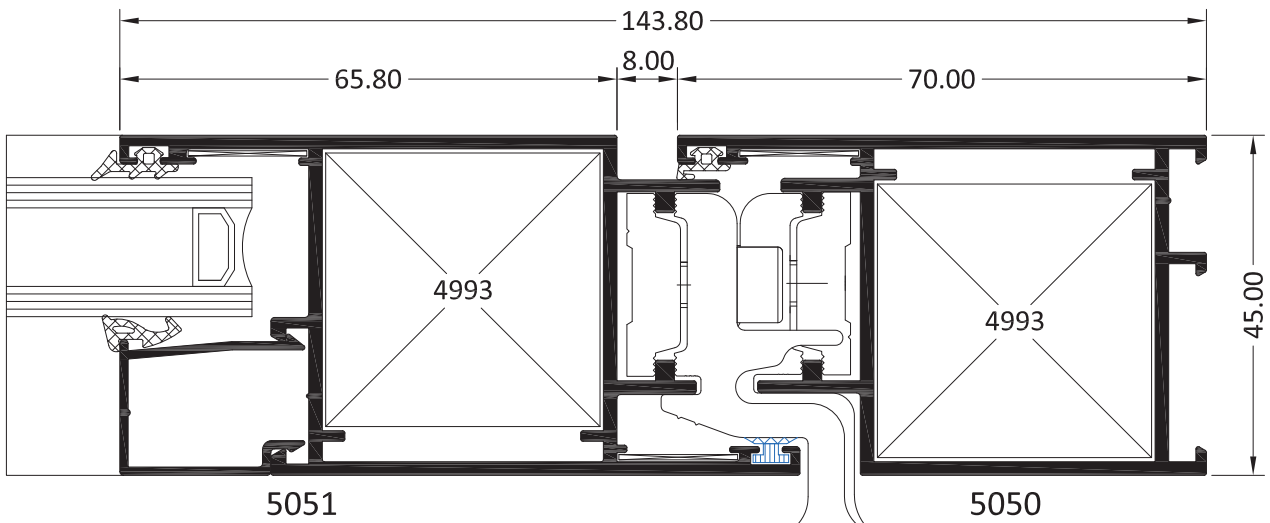

SECCIÓN 5

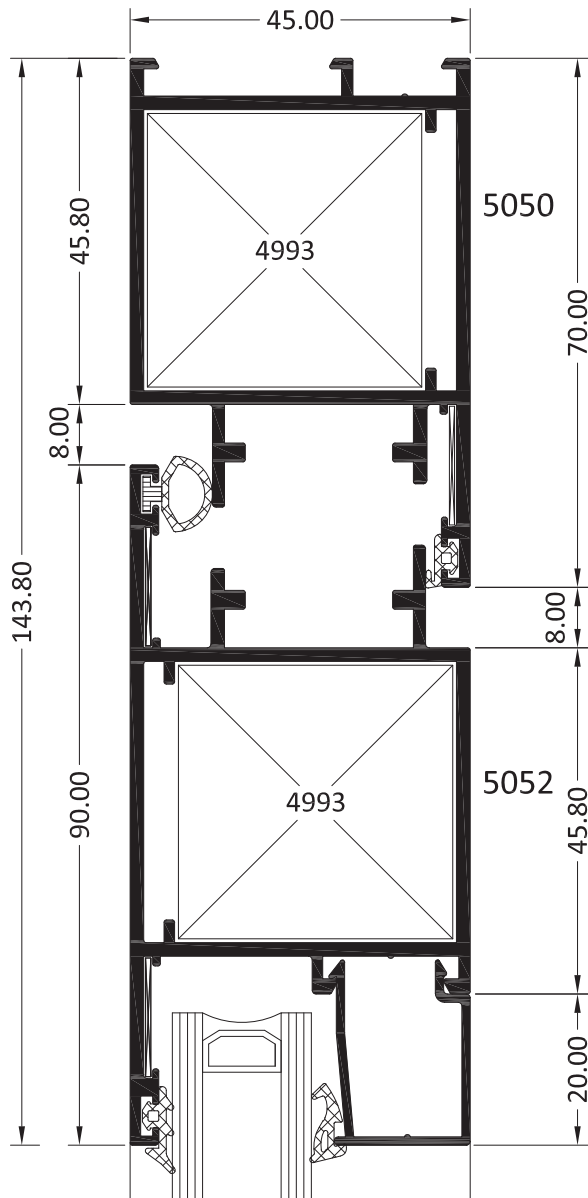

SECCIÓN 7

7. SECCIONES

SECCIÓN 8

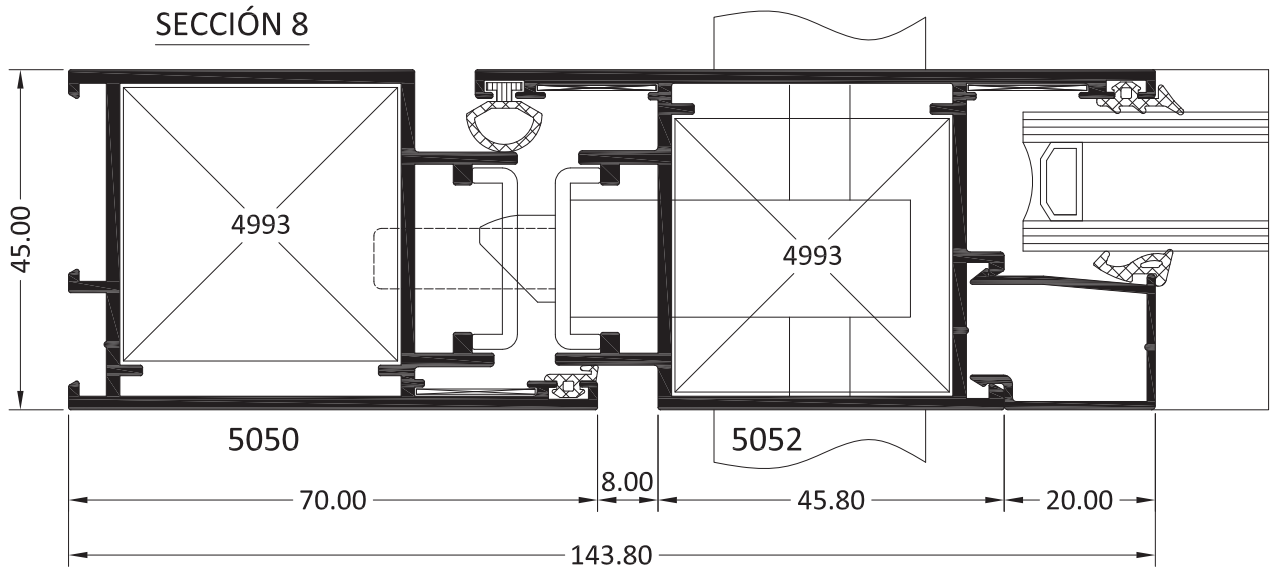

SECCIÓN 15

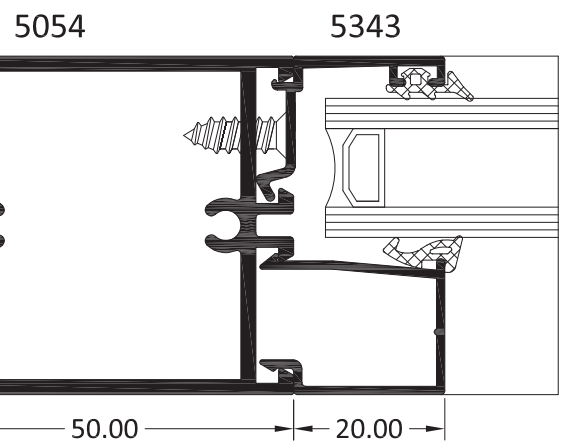

5343

20.00
70.00

5054

SECCIÓN 13

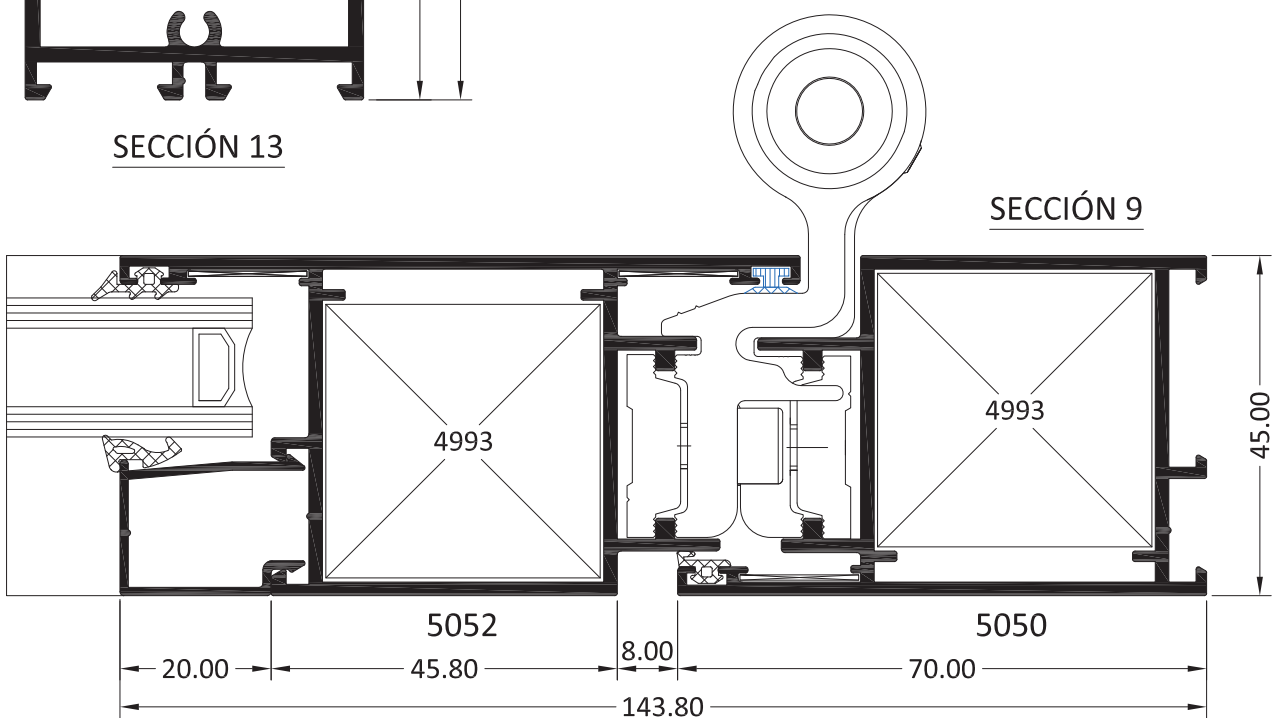

SECCIÓN 9

4993

4993

45.00

5052

5050

20.00

45.80

8.00

70.00

143.80

7. SECCIONES

SECCIÓN 11

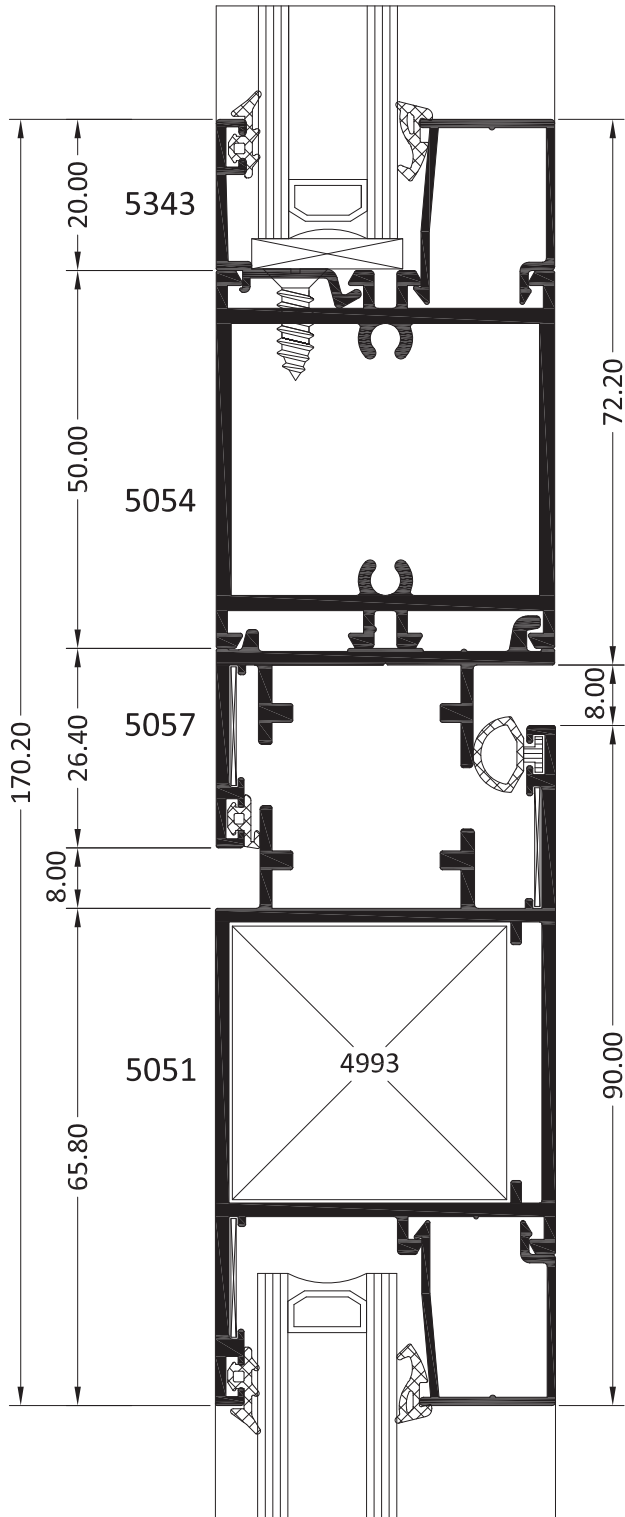

SECCIÓN 12

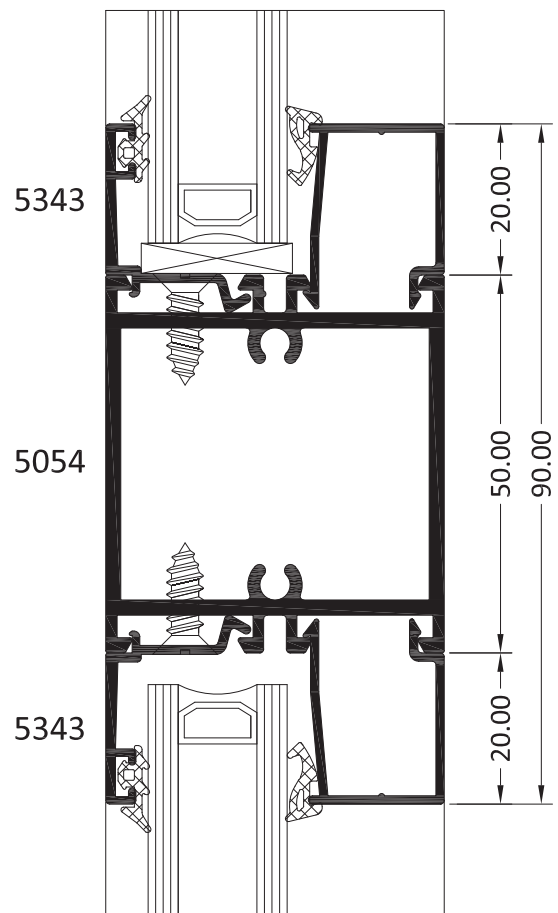
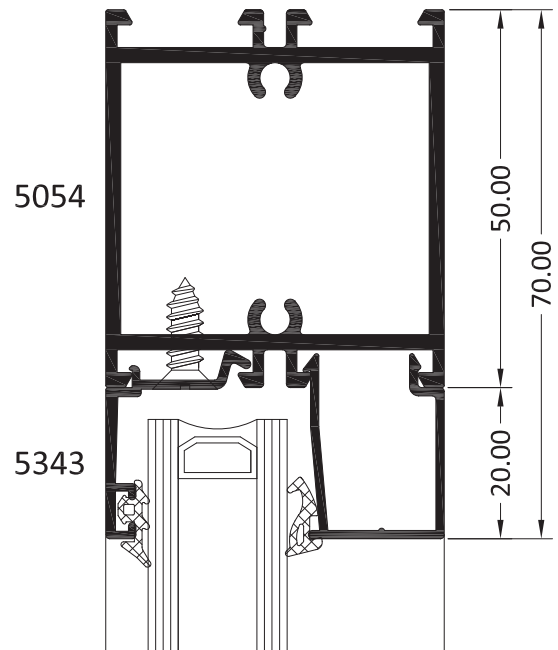

SECCIÓN 14

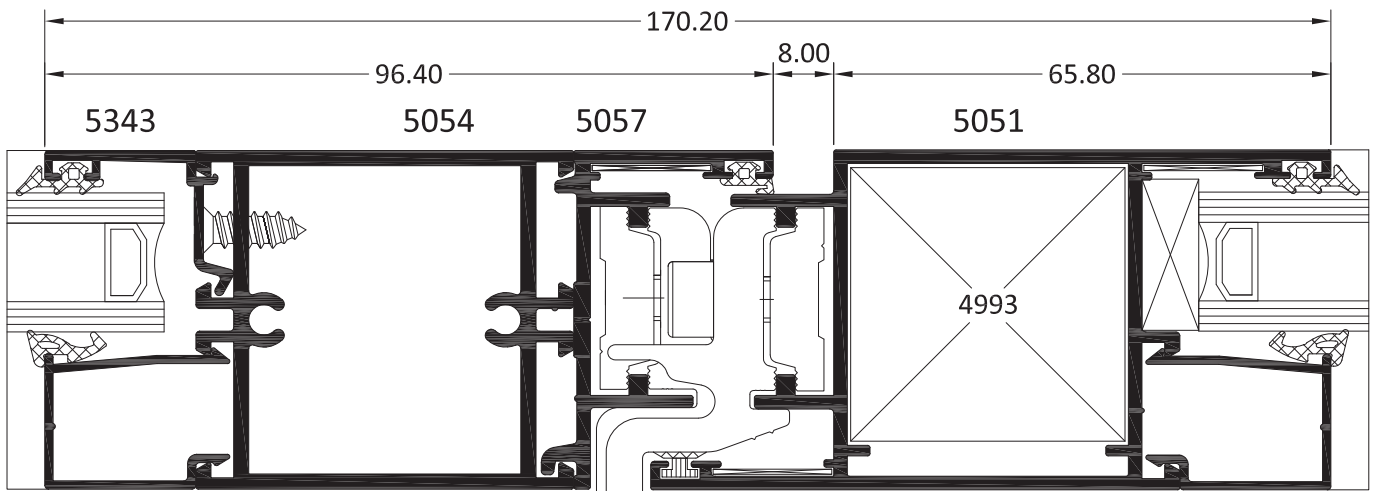
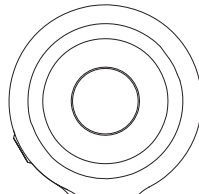
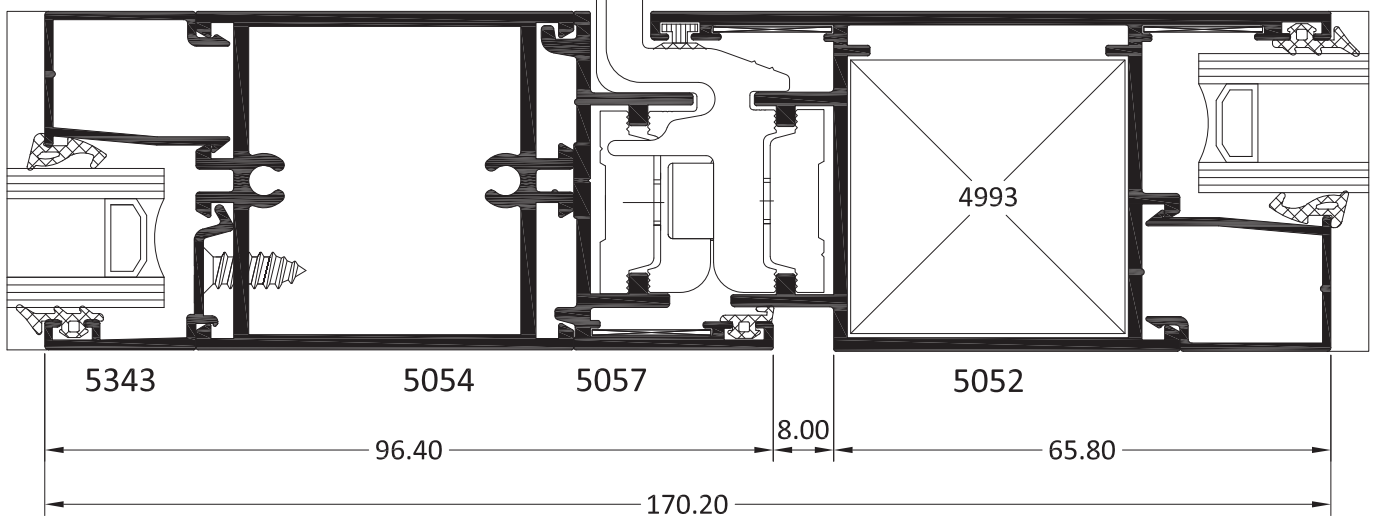
7. SECCIONES**SECCIÓN 16****SECCIÓN 18**

7. SECCIONES

SECCIÓN 17

SECCIÓN 24

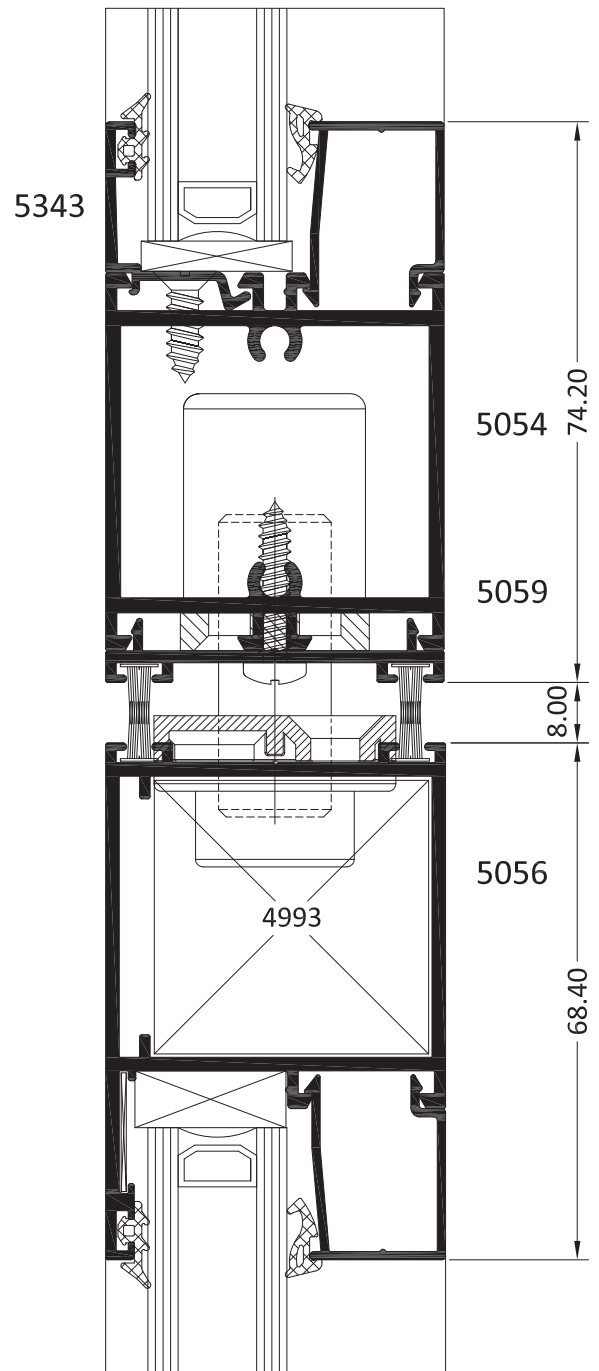
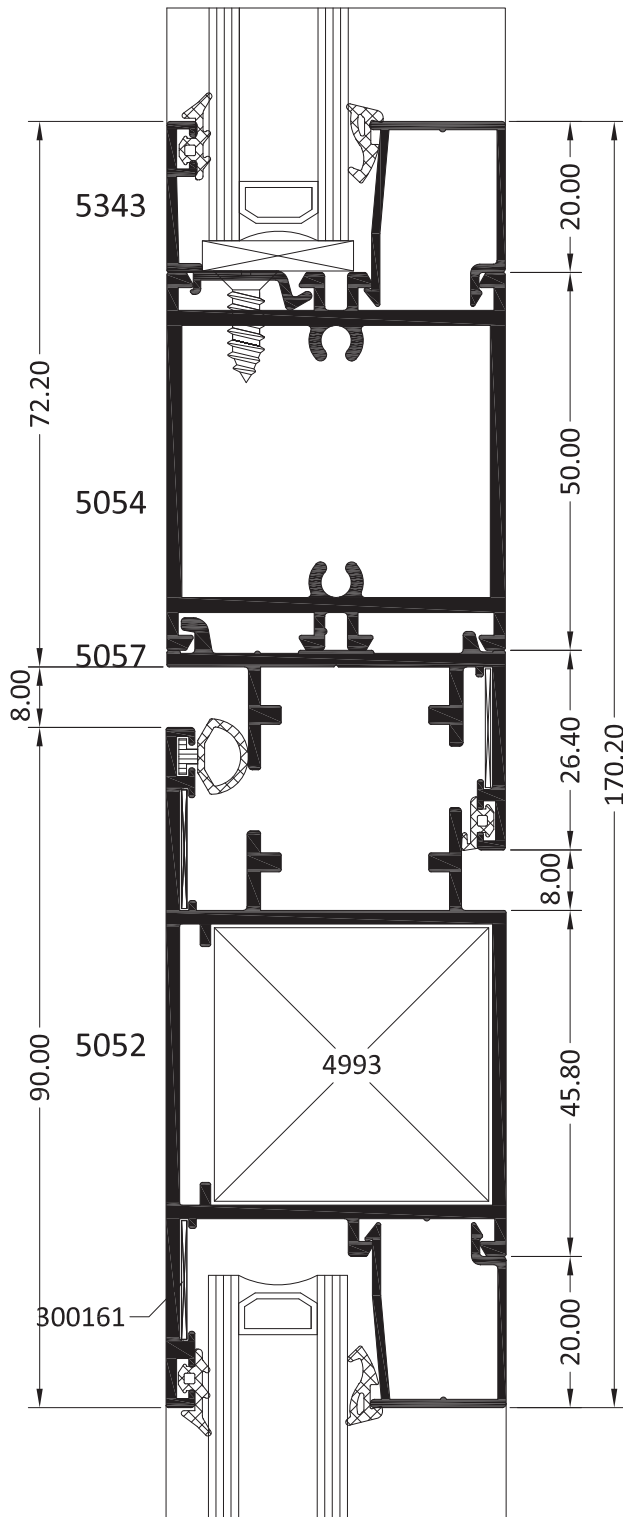

7. SECCIONES

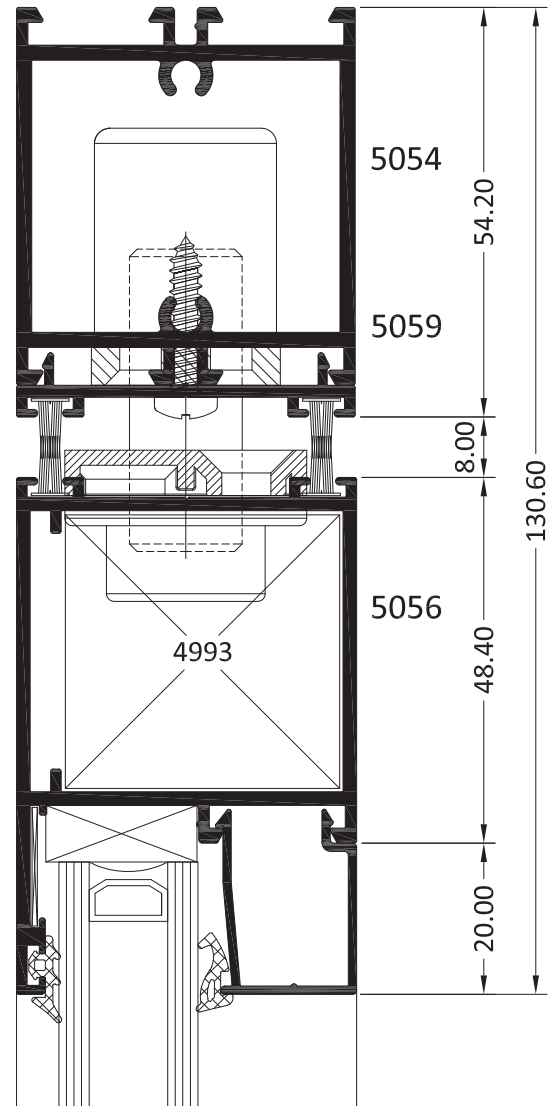
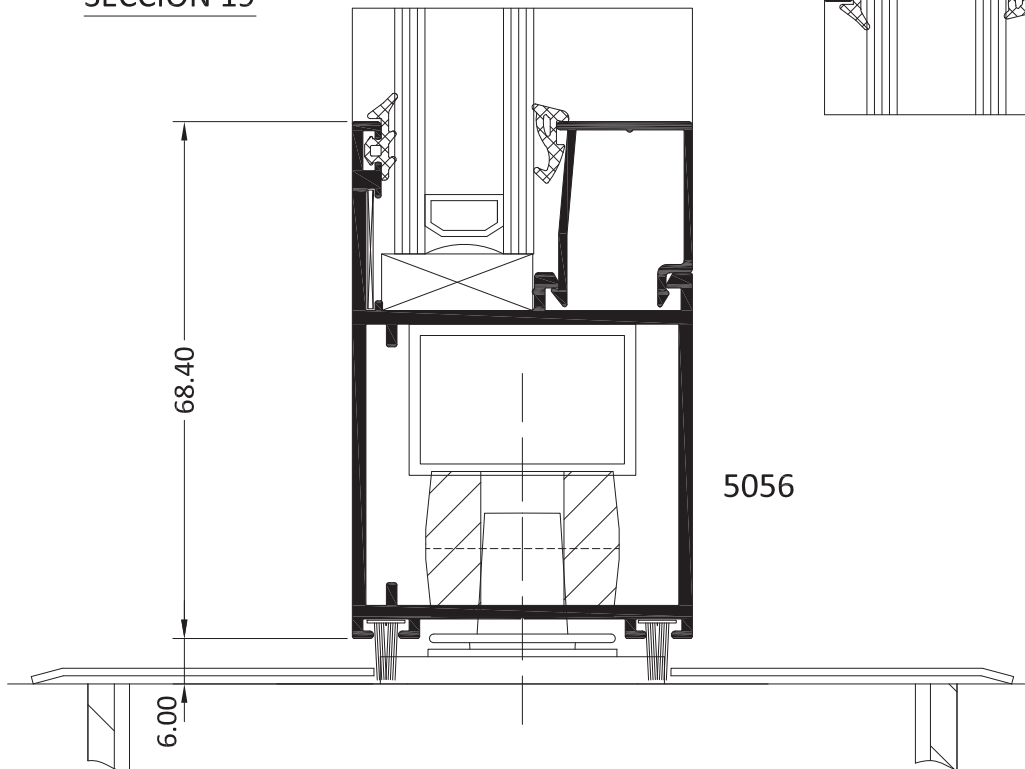
SECCIÓN 20SECCIÓN 19

7. SECCIONES

SECCIÓN 21

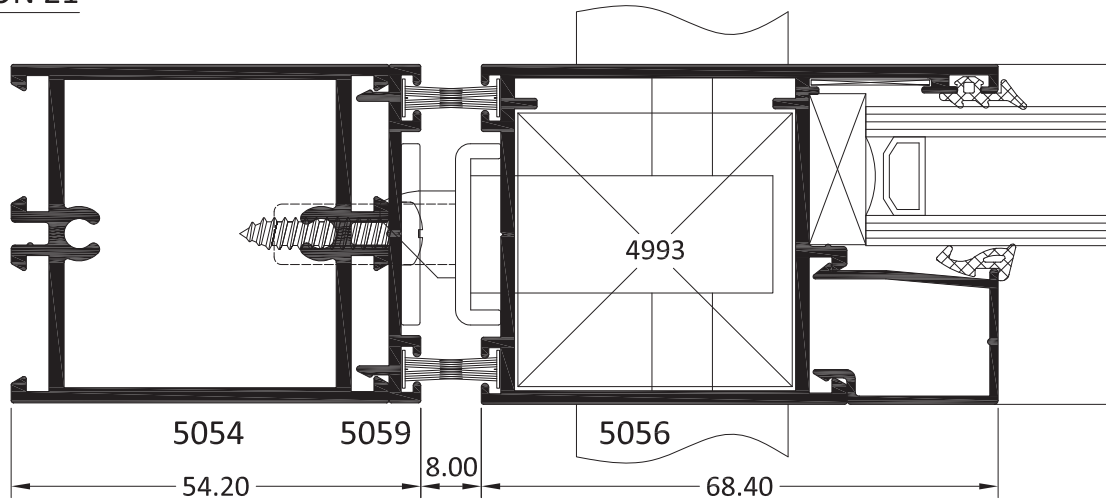

SECCIÓN 22

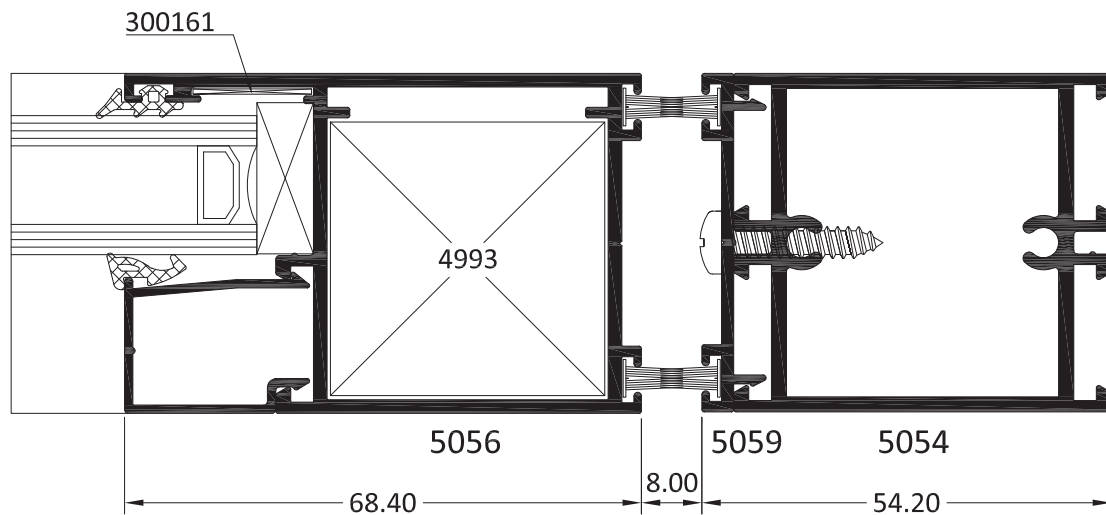

SECCIÓN 23

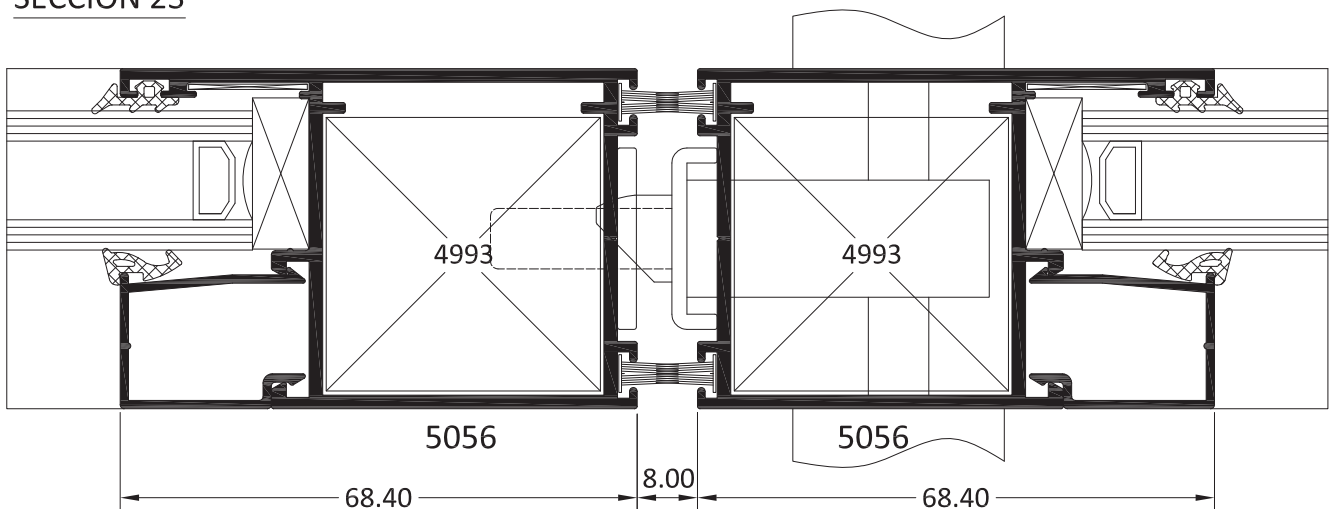

8. HOJAS DE CORTE. PUERTA DE 1 HOJA APERTURA INTERIOR

ESCALA 1:3

ALZADO

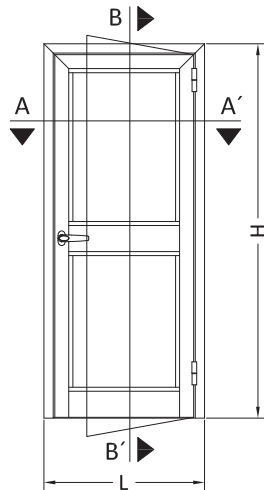

SECCIÓN VERTICAL B-B'

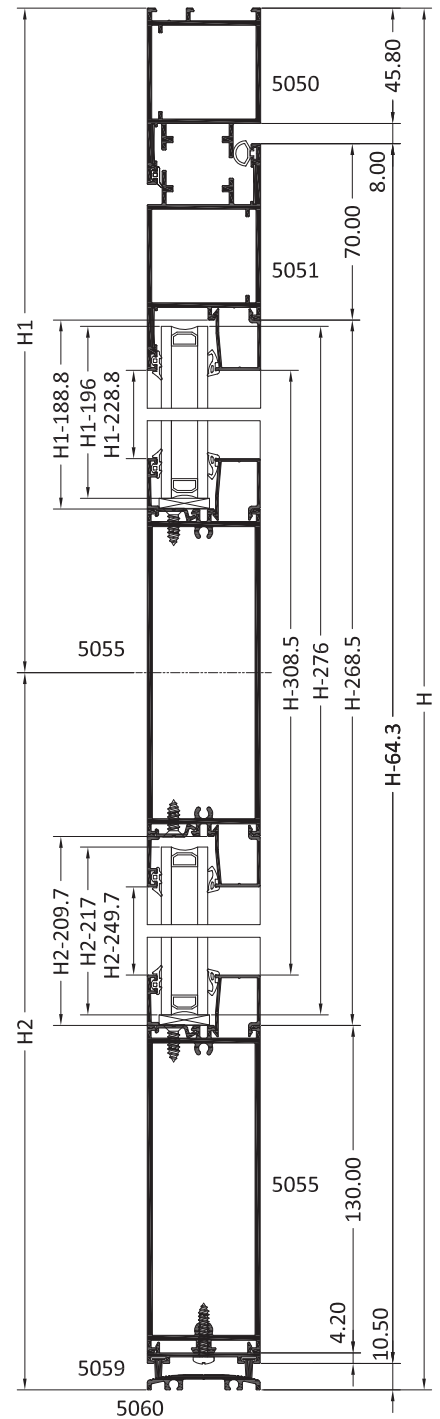

LISTA DE CORTE	PERFIL	DENOMINACIÓN	CORTE
	5050	Marco	2 \square H \square + 1 \square L \square
	5051	Hoja apertura int	2 \square H-64.3 \square + 1 \square L-107.6 \square
	5055	Travesaño 130	1 \square L-247.6 \square
	5059	Suplemento zócalo	1 \square L-247.6 \square
	5060	Cierre suelo	1 \square L-91.6 \square
	5343	Junquillo recto 4	1 \square L-247.6 \square
	(*)	Junquillo interior	2 \square H-308.5 \square + 2 \square L-247.6 \square
Vidrio (1 ud. L-255 x H-276)			
Con travesaño (1ud. L-255 x H1-196 + 1ud L-255 x H2 -217)			

(*) Para la elección de junquillo consultar hoja de acristalamiento

ACCESORIOS	REFERENCIA	DENOMINACIÓN	UDS.
	(según color)	Bisagra	2
	(según color)	Manilla puerta	1
	301360	Cerradura 1 Pto.	1
	301361	Cerradero	1
	300573	Cilindro PC-45	1
	301365	Escuadra bloqueo	4
	300161	Escuadra alineación	6
	301396	Junta marco	2 \square H-63 \square + 1 \square L-125 \square
	301395	Junta burbuja hoja	2 \square H-63 \square + 1 \square L-110 \square
	301394	Felpa inferior	2 \square L-247.6 \square
	300532	Junta acristalar exterior	2 \square H-290 \square + 1 \square L-272 \square
	(**)	Junta acristalar interior	2 \square H-290 \square + 1 \square L-272 \square

(**) Para la elección de la junta de acristalamiento interior consultar hoja de acristalamiento

SECCIÓN HORIZONTAL A-A'

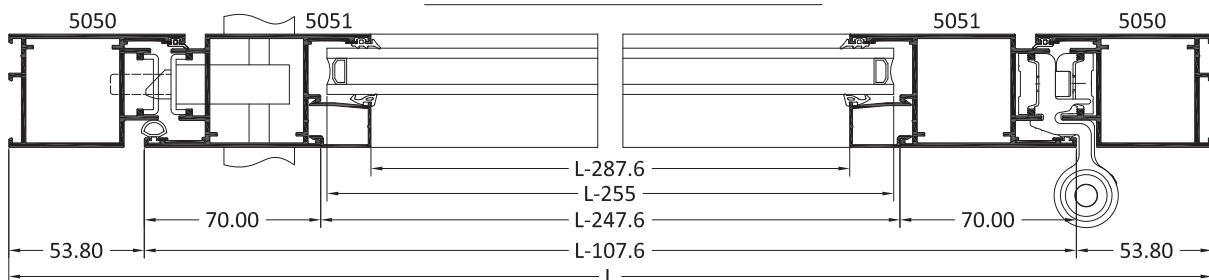

8. HOJAS DE CORTE. PUERTA DE 1 HOJA APERTURA EXTERIOR

ESCALA 1:3

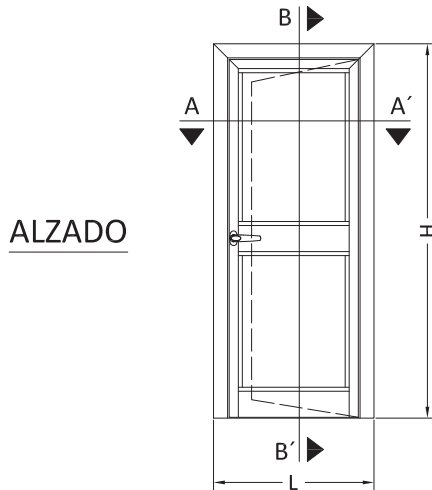

SECCIÓN VERTICAL B-B'

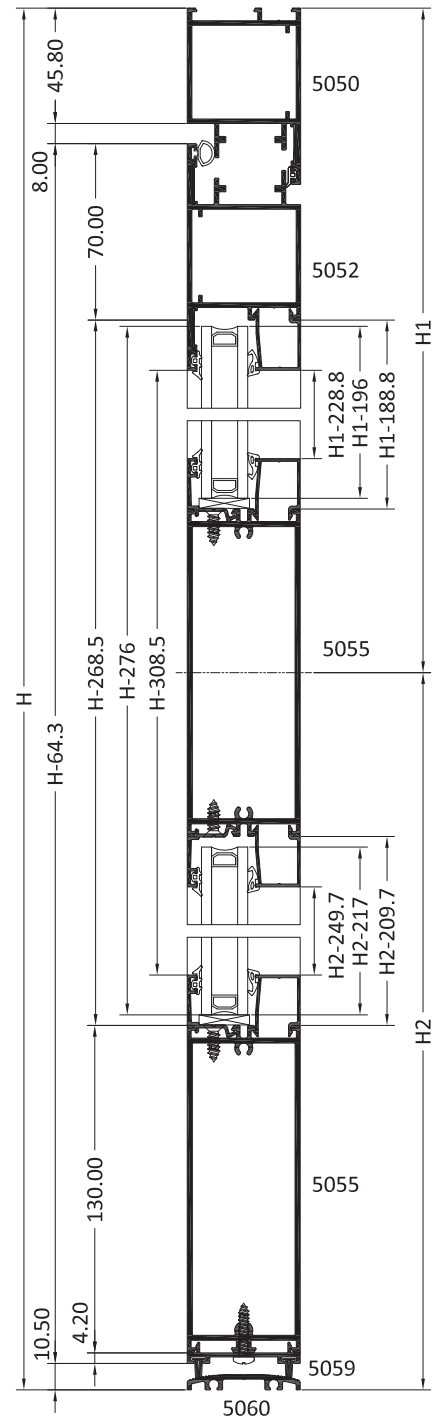

LISTA DE CORTE	PERFIL	DENOMINACIÓN	CORTE
	5050	Marco	2 \square H + 1 \square L
	5052	Hoja apertura exterior	2 \square H-64.3 + 1 \square L-107.6
	5055	Travesaño 130	1 \square L-247.6
	5059	Suplemento zócalo	1 \square L-247.6
	5060	Cierre suelo	1 \square L-91.6
	5343	Junquillo recto 4	1 \square L-247.6
	(*)	Junquillo interior	2 \square H-308.5 + 2 \square L-247.6
Vidrio (1 ud. L-255 x H-276)			
Con travesaño (1ud. L-255 x H1-196 + 1ud L-255 x H2 -217)			

(*) Para la elección de junquillo consultar hoja de acristalamiento

ACCESORIOS	REFERENCIA	DENOMINACIÓN	UDS.
	(según color)	Bisagra	2
	(según color)	Manilla puerta	1
	301360	Cerradura 1 Pto.	1
	301361	Cerradero	1
	300573	Cilindro PC-45	1
	301365	Escuadra bloqueo	4
	300161	Escuadra alineación	6
	301396	Junta marco	2 \square H-63 + 1 \square L-125
	301395	Junta burbuja hoja	2 \square H-63 + 1 \square L-110
	301394	Felpa inferior	2 \square L-247.6
	300532	Junta acristalar exterior	2 \square H-290 + 1 \square L-272
	(**)	Junta acristalar interior	2 \square H-290 + 1 \square L-272

(**) Para la elección de la junta de acristalamiento interior consultar hoja de acristalamiento

SECCIÓN HORIZONTAL A-A'

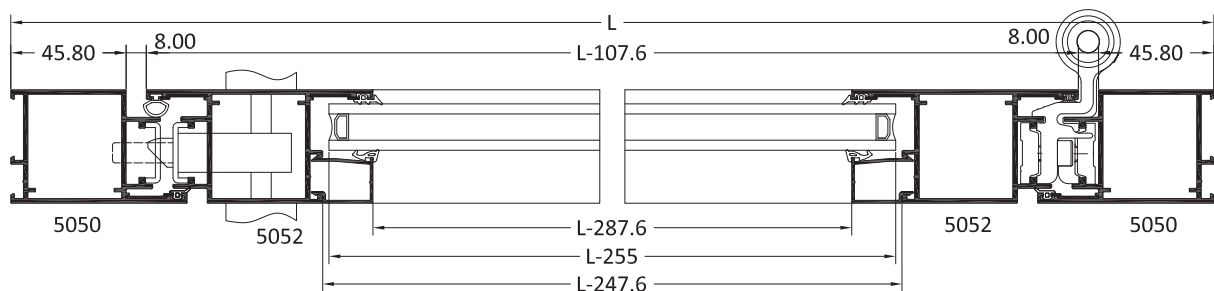

8. HOJAS DE CORTE. PUERTA DE 2 HOJAS APERTURA INTERIOR

ESCALA 1:3

ALZADO

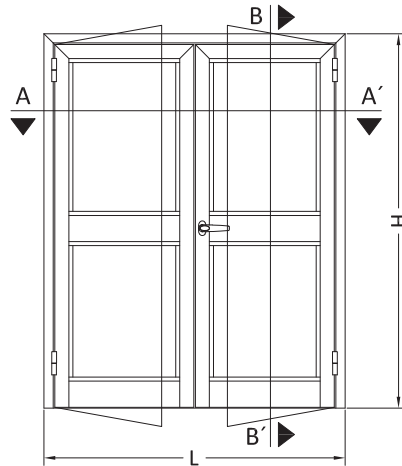

SECCIÓN VERTICAL B-B'

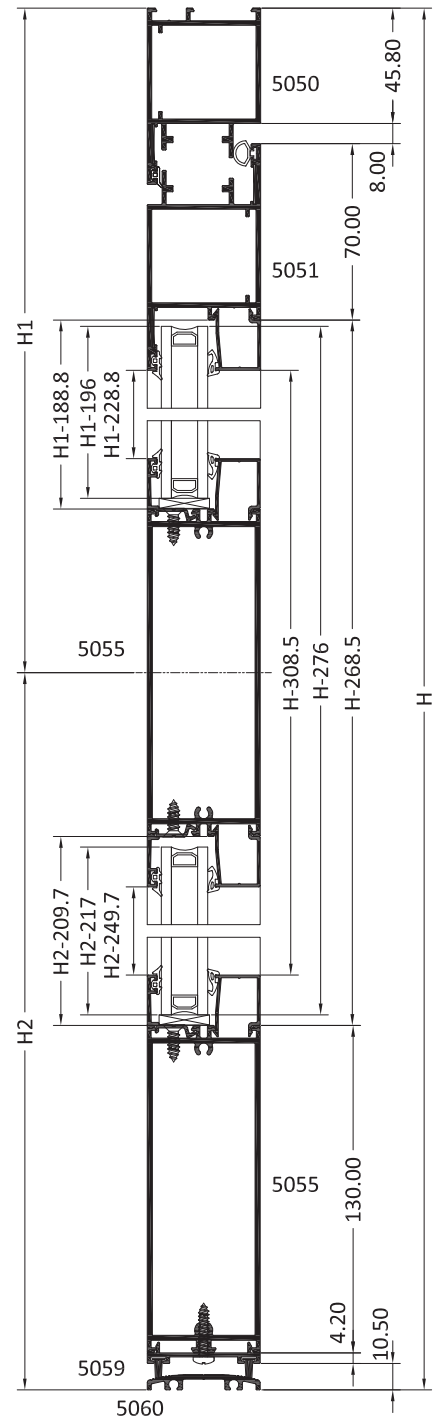

LISTA DE CORTE	PERFIL	DENOMINACIÓN	CORTE
	5050	Marco	2
5051	Hoja apertura interior	2	H-64.3 + 2 L/2-57.8
5053	Inversor	1	H-88.5
5055	Travesaño 130	2	L/2-197.8
5059	Suplemento zócalo	2	L/2-197.8
5060	Cierre suelo	1	L-91.6
5343	Junquillo recto 4	2	L/2-197.8
(*)	Junquillo interior	4	H-308.5 + 4 L/2-197.8
Vidrio (2 uds. L/2-205 x H-276)			
Con travesaño (2uds. L/2-205 x H1-196 + 2ud L/2-205 x H2 -217)			

(*) Para la elección de junquillo consultar hoja de acristalamiento

ACCESORIOS	REFERENCIA	DENOMINACIÓN	UDS.
	(según color)		Bisagra
(según color)		Manilla puerta	1
	301360	Cerradura 1 Pto.	1
	301361	Cerradero	1
	300573	Cilindro PC-45	1
	301365	Escuadra bloqueo	4
	300161	Escuadra alineación	6
	301386	Pasador superior	1
	301387	Pasador corto inferior	1
	301389	Cerradero doble	1
	300742	Encuentro cierre a suelo	1
	301356	Juego tapas inversor	1
	301396	Junta marco	2 H-63 + 1 L-125
	301395	Junta burbuja hoja	4 H-63 + 2 L-110
	301394	Felpa inferior	2 L/2-197.8
	300532	Junta acristalar exterior	2 H-290 + 1 L-272
	(**)	Junta acristalar interior	2 H-290 + 1 L-272

(**) Para la elección de la junta de acristalamiento interior consultar hoja de acristalamiento

SECCIÓN HORIZONTAL A-A'

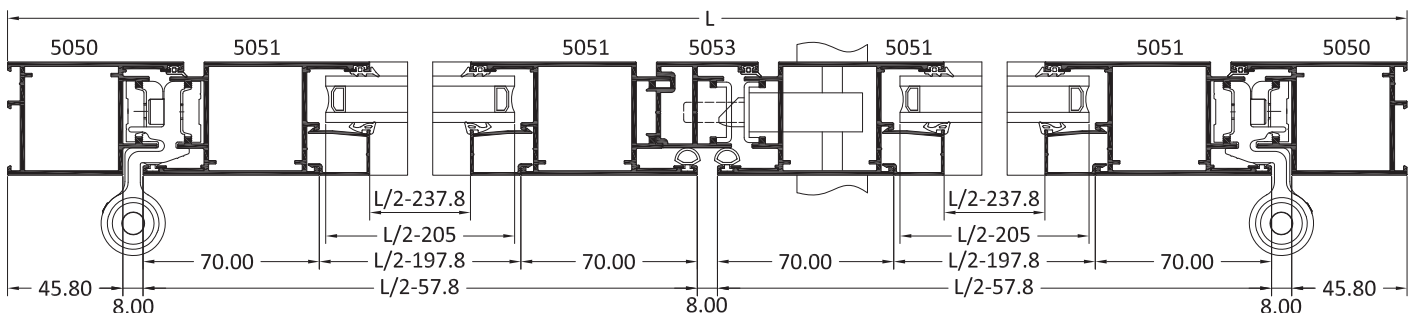

8. HOJAS DE CORTE. PUERTA DE 2 HOJAS APERTURA EXTERIOR

ESCALA 1:3

ALZADO

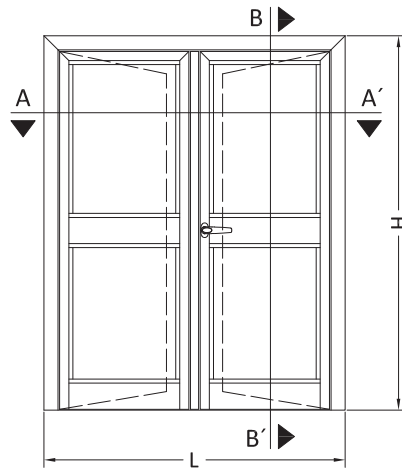

SECCIÓN VERTICAL B-B'

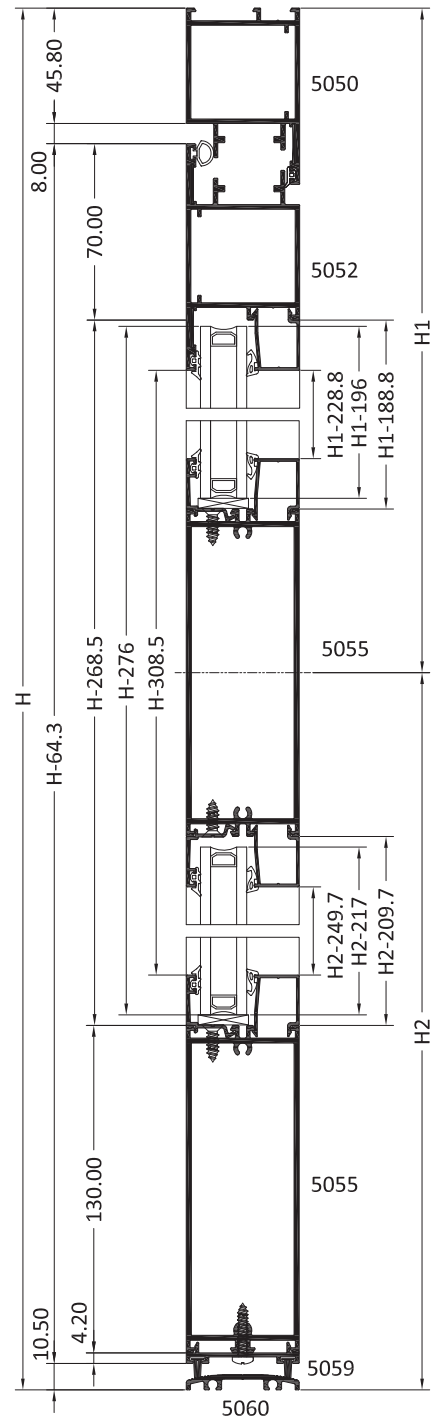

LISTA DE CORTE	PERFIL	DENOMINACIÓN	CORTE
	5050	Marco	2 $\frac{H}{L}$ + 1 $\frac{L}{H}$
	5052	Hoja apertura exterior	2 $\frac{H-64.3}{L/2-57.8}$ + 2 $\frac{L/2-57.8}{H-64.3}$
	5053	Inversor	1 $\frac{H-88.5}{L/2-197.8}$
	5055	Travesaño 130	2 $\frac{L/2-197.8}{H-268.5}$
	5059	Suplemento zócalo	2 $\frac{L/2-197.8}{H-276}$
	5060	Cierre suelo	1 $\frac{L-91.6}{H-308.5}$
	5343	Junquillo recto 4	2 $\frac{L/2-197.8}{H-268.5}$
	(*)	Junquillo interior	4 $\frac{H-308.5}{L/2-197.8}$ + 4 $\frac{L/2-197.8}{H-308.5}$
Vidrio (2 uds. L/2-205 x H-276)			
Con travesaño (2uds. L/2-205 x H1-196 + 2ud L/2-205 x H2 -217)			

(*) Para la elección de junquillo consultar hoja de acristalamiento

ACCESORIOS	REFERENCIA	DENOMINACIÓN	UDS.
	(según color)	Bisagra	4
	(según color)	Manilla puerta	1
	301360	Cerradura 1 Pto.	1
	301361	Cerradero	1
	300573	Cilindro PC-45	1
	301365	Escuadra bloqueo	4
	300161	Escuadra alineación	6
	301386	Pasador superior	1
	301387	Pasador corto inferior	1
	301389	Cerradero doble	1
	300742	Encuentro cierre a suelo	1
	301356	Juego tapas inversor	1
	301396	Junta marco	2 $\frac{H-63}{L-125}$ + 1 $\frac{L-125}{H-63}$
	301395	Junta burbuja hoja	4 $\frac{H-63}{L-110}$ + 2 $\frac{L-110}{H-63}$
	301394	Felpa inferior	2 $\frac{L/2-197.8}{H-268.5}$
	300532	Junta acristalar exterior	2 $\frac{H-290}{L-272}$ + 1 $\frac{L-272}{H-290}$
(**)	Junta acristalar interior	2 $\frac{H-290}{L-272}$ + 1 $\frac{L-272}{H-290}$	

(**) Para la elección de la junta de acristalamiento interior consultar hoja de acristalamiento

SECCIÓN HORIZONTAL A-A'

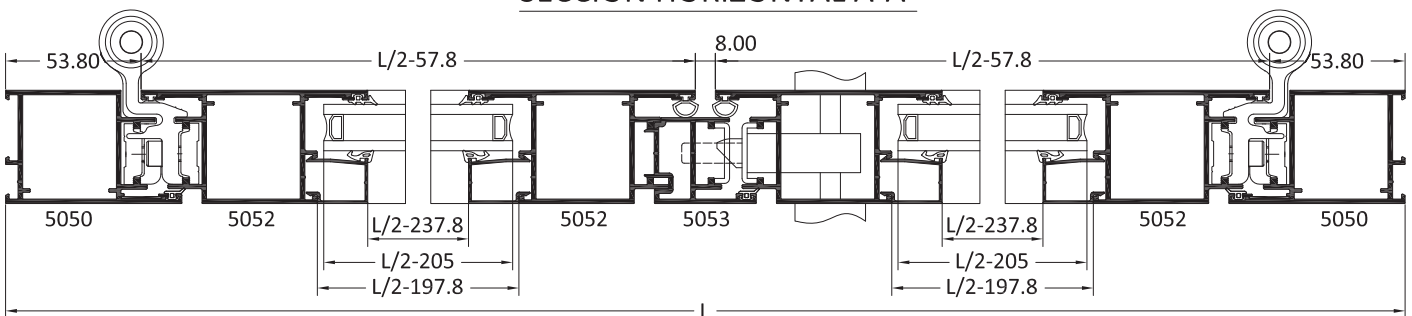

8. HOJAS DE CORTE. PUERTA DE 2 HOJAS APERTURA INTERIOR CON FIJOS

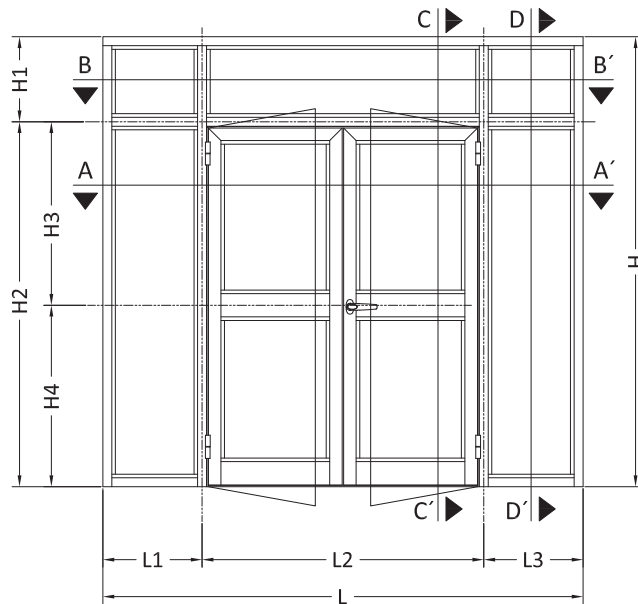

LISTA DE CORTE	PERFIL	DENOMINACIÓN	CORTE
	5054	Travesaño 50	4 \square H-50 + 2 \square L1-75 + 2 \square L3-75 1 \square L2-50 + 1 \square L
	5051	Hoja apertura interior	4 \triangle H2-45.7 + 2 \triangle L2/2-39.2
	5053	Inversor	1 \square H-88.5
	5055	Travesaño 130	4 \square L2/2-179.2
	5059	Suplemento zócalo	2 \square L2/2-179.2
	5060	Cierre suelo	1 \square L2-54.4
	5343	Junquillo recto 4	6 \square H1-115 + 4 \square H2-117.2 + 4 \square H3-210.2 + 4 \square H4-249.7 + 4 \square L1-80 + 4 \square L3-80 + 2 \square L2-50 + 8 \square L2/2-179
	(*)	Junquillo interior	6 \square H1-115 + 4 \square H2-117.2 + 4 \square H3-210.2 + 4 \square H4-249.7 + 4 \square L1-80 + 4 \square L3-80 + 2 \square L2-50 + 8 \square L2/2-179
	Vidrios: 1(L1-80 x H1-115)+1(L1-80 x H2-83)+1(L3-80 x H1-115)+1(L3-80 x H2-83)+1(L2-55 x H1-115)+2(L2/2-185xH2-83)		
Con travesaño en hojas - Vidrios: 1 (L1-80 x H1-115)+1 (L1-80 x H2-83)+1 (L3-80 x H1-115)+1 (L3-80 x H2-83)+ 1 (L2-55 x H1-115)+2 (L2/2-185 x H1-176)+2 (L2/2-185 x H2-217)			

(*) Para la elección de junquillo consultar hoja de acristalamiento

ACCESORIOS	REFERENCIA	DENOMINACIÓN	UDS.
	(según color)	Bisagra	4
	(según color)	Manilla puerta	1
	301360	Cerradura 1 Pto.	1
	301361	Cerradero	1
	300573	Cilindro PC-45	1
	301365	Escuadra bloqueo	4
	300161	Escuadra alineación	6
	301386	Pasador superior	1
	301387	Pasador corto inferior	1
	301389	Cerradero doble	1
	300742	Encuentro cierre a suelo	1
	301356	Juego tapas inversor	1
	301396	Junta marco	2 \triangle H2-44 + 1 \triangle L2-88
	301395	Junta burbuja hoja	4 \triangle H2-54 + 2 \triangle L2/2-37
	301394	Felpa inferior	2 \square L2/2-179.2
	300532	Junta acristalar exterior	8 \triangle H + 6 \triangle L
(**)	Junta acristalar interior	8 \triangle H + 6 \triangle L	

(**) Para la elección de la junta de acristalamiento interior consultar hoja de acristalamiento

8. HOJAS DE CORTE. PUERTA DE 2 HOJAS APERTURA EXTERIOR CON FIJOS

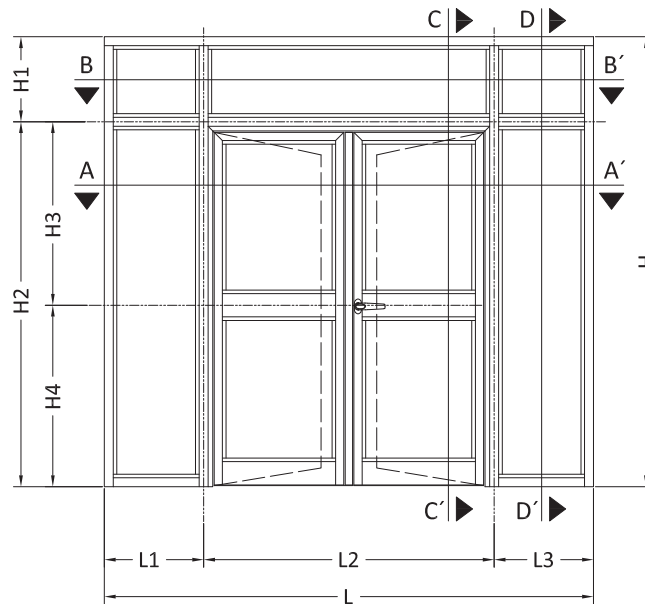

LISTA DE CORTE	PERFIL	DENOMINACIÓN	CORTE
	5054	Travesaño 50	4 $\boxed{H-50}$ + 2 $\boxed{L1-75}$ + 2 $\boxed{L3-75}$ 1 $\boxed{L2-50}$ + 1 \boxed{L}
	5052	Hoja apertura exterior	4 $\boxed{H2-45.7}$ + 2 $\boxed{L2/2-39.2}$
	5053	Inversor	1 $\boxed{H-88.5}$
	5055	Travesaño 130	4 $\boxed{L2/2-179.2}$
	5059	Suplemento zócalo	2 $\boxed{L2/2-179.2}$
	5060	Cierre suelo	1 $\boxed{L2-54.4}$
	5343	Junquillo recto 4	6 $\boxed{H1-115}$ + 4 $\boxed{H2-117.2}$ + 4 $\boxed{H3-210.2}$ 4 $\boxed{H4-249.7}$ + 4 $\boxed{L1-80}$ + 4 $\boxed{L3-80}$ 2 $\boxed{L2-50}$ + 8 $\boxed{L2/2-179}$
	(*)	Junquillo interior	6 $\boxed{H1-115}$ + 4 $\boxed{H2-117.2}$ + 4 $\boxed{H3-210.2}$ 4 $\boxed{H4-249.7}$ + 4 $\boxed{L1-80}$ + 4 $\boxed{L3-80}$ 2 $\boxed{L2-50}$ + 8 $\boxed{L2/2-179}$
	Vidrios: 1(L1-80 x H1-115)+1(L1-80 x H2-83)+1(L3-80 x H1-115)+1(L3-80 x H2-83)+1(L2-55 x H1-115)+2(L2/2-185xH2-83)		
Con travesaño en hojas - Vidrios: 1 (L1-80 x H1-115)+1 (L1-80 x H2-83)+1 (L3-80 x H1-115)+1 (L3-80 x H2-83)+ 1 (L2-55 x H1-115)+2 (L2/2-185 x H1-176)+2 (L2/2-185 x H2-217)			

(*) Para la elección de junquillo consultar hoja de acristalamiento

ACCESORIOS	REFERENCIA	DENOMINACIÓN	UDS.
	(según color)	Bisagra	4
	(según color)	Manilla puerta	1
	301360	Cerradura 1 Pto.	1
	301361	Cerradero	1
	300573	Cilindro PC-45	1
	301365	Escuadra bloqueo	4
	300161	Escuadra alineación	6
	301386	Pasador superior	1
	301387	Pasador corto inferior	1
	301389	Cerradero doble	1
	300742	Encuentro cierre a suelo	1
	301356	Juego tapas inversor	1
	301396	Junta marco	2 $\boxed{H2-44}$ + 1 $\boxed{L2-88}$
	301395	Junta burbuja hoja	4 $\boxed{H2-54}$ + 2 $\boxed{L2/2-37}$
	301394	Felpa inferior	2 $\boxed{L2/2-179.2}$
	300532	Junta acristalar exterior	8 \boxed{H} + 6 \boxed{L}
(**)	Junta acristalar interior	8 \boxed{H} + 6 \boxed{L}	

(**) Para la elección de la junta de acristalamiento interior consultar hoja de acristalamiento